







# ASSEMBLY INSTRUCTIONS

## MODEL: PL150SGD + PL151SGD-A3

Before assembly, please remove all parts from the carton, verifying that you have the correct quantities, and read all the instructions.

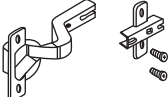
### IN THE CARTON:

<p>1</p>  <p>Glass Pads 4 Pcs</p>	<p>2</p>  <p>Self-Drilling Screws 8 Pcs</p>	<p>3</p>  <p>Handle Screws 4 Pcs</p>	<p>A</p>  <p>Aluminium Glass Door</p>	<p>*4</p>  <p>Softclosing Door Hinges 3 Set Included in cabinet box</p>	<p>*5</p>  <p>Wood Screws 6 Pcs</p>	<p>*6</p>  <p>Handle 1 Pcs (not include)</p>
--	--	---	--	--	--	---

\*HARDWARE FROM PL150

### INSTRUCTIONS:

Optional : door can be left or right!

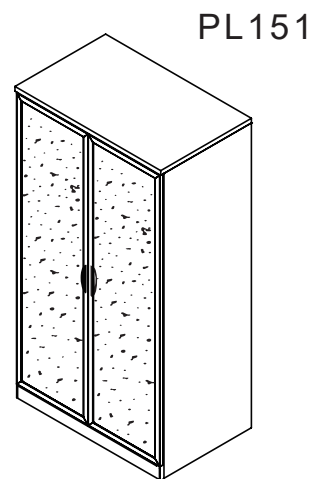
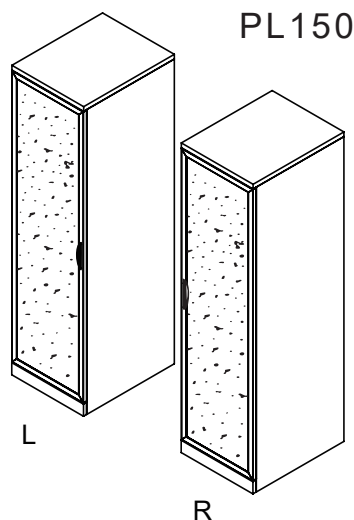
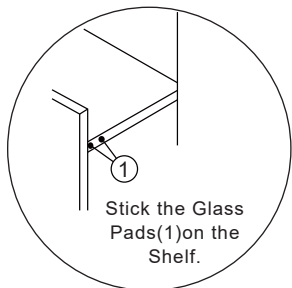
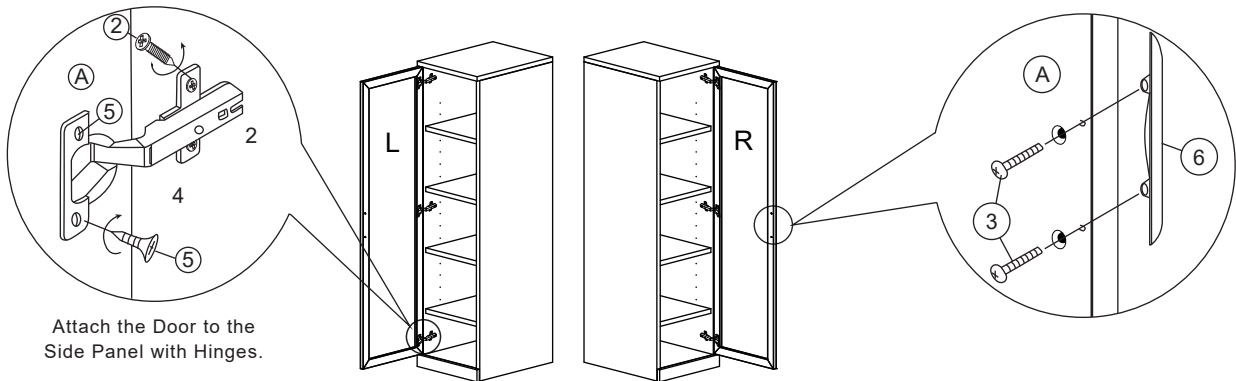

For PL151, complete above steps as a LH door, and then as a RH door. (2 doors required.)

### ⚠ ATTENTION ⚠

Place all wooden parts on a clean and smooth surface such as a rug or carpet to avoid the parts from being scratched. Check that you have all parts and hardware. Remove all wrapping materials, including staples & packing straps before you start to assemble. Do not tighten any screws or bolts until the unit is completely assembled. Keep all hardware parts out of reach of children. There may be extra hardware when install is complete.