

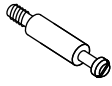





HARDWARE

<p>1</p>  <p>CAM LOCK 4 Pcs</p>	<p>2</p>  <p>KLIX CAM 4 Pcs</p>	<p>3</p>  <p>HOUSING CAP (LONG) 4 Pcs</p>	<p>4</p>  <p>SCREW M6 x 40MM 4 Pcs</p>	<p>5</p>  <p>WASHER 4 Pcs</p>	<p>6</p>  <p>M4 x 65 ALLEN-KEY 1 Pc</p>	<p>7</p>  <p>ADJUSTABLE GLIDE 6 Pcs</p>
---	---	---	--	--	---	---

COMPONENTS

<p>A</p>  <p>FRONT/BACK PANEL</p>	<p>B</p>  <p>SIDE PANEL x 2</p>	<p>C</p>  <p>BOTTOM RAIL x 2</p>	<p>D</p>  <p>COMPOSE END TABLE CUBE (SOLD SEPERATELY)</p>
---	---	---	---

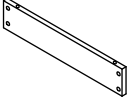
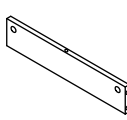
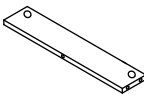
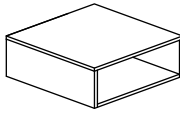
KLIX CAM INSTRUCTIONS

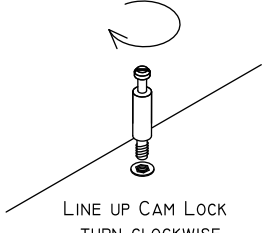
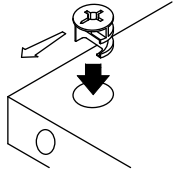
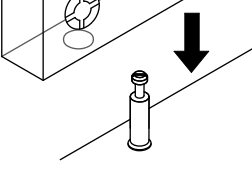
<p>1</p>  <p>LINE UP CAM LOCK TURN CLOCKWISE.</p>	<p>2</p>  <p>INSERT THE CAM WITH THE ARROW POINTING TOWARDS THE HOLE IN THE EDGE.</p>	<p>3</p>  <p>INSERT THE CAM LOCK INTO KLIX CAM. TURN KLIX CAM TO LOCK.</p>
--	--	---

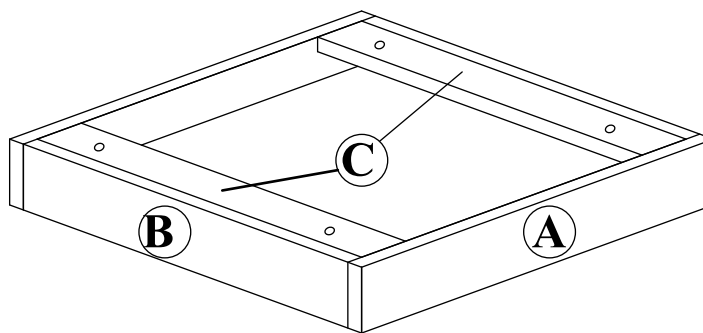

IMPORTANT NOTE :

- Place all wooden parts on a clean, smooth surface to prevent the parts from being scratched.
- Check that you have all parts and hardware.
- Remove all wrapping materials, including staples & packing straps before you start to assemble.
- Do not tighten any screws or bolts until the unit is completely assembled.
- Keep all hardware parts out of reach of children.

